



Micro Commercial Components

Micro Commercial Components
 20736 Marilla Street Chatsworth
 CA 91311
 Phone: (818) 701-4933
 Fax: (818) 701-4939

DTC144ECA

Features

- Case Material: Molded Plastic. UL Flammability Classification Rating 94V-0 and MSL Rating 1
- Built-in bias resistors enable the configuration of an inverter circuit without connecting external input resistors
- The bias resistors consist of thin-film resistors with complete isolation to allow negative biasing of the input. They also have the advantage of almost completely eliminating parasitic effects.
- Only the on/off conditions need to be set for operation, making device design easy

Absolute maximum ratings @ 25°C

Symbol	Parameter	Min	Typ	Max	Unit
V_{CC}	Supply voltage	---	50	---	V
V_{IN}	Input voltage	-10	---	40	V
I_O	Output current	---	100	---	mA
P_d	Power dissipation	---	200	---	mW
T_j	Junction temperature	---	150	---	°C
T_{stg}	Storage temperature	-55	---	150	°C

Electrical Characteristics @ 25°C

Symbol	Parameter	Min	Typ	Max	Unit
$V_{I(off)}$	Input voltage ($V_{CC}=5V, I_O=100\mu A$)	---	---	0.5	V
$V_{I(on)}$		3.0	---	---	V
$V_{O(on)}$	Output voltage ($I_O/I_I=10mA/0.5mA$)	---	---	0.3	V
I_I	Input current ($V_I=5V$)	---	---	0.18	mA
$I_{O(off)}$	Output current ($V_{CC}=50V, V_I=0$)	---	---	0.5	μA
G_I	DC current gain ($V_O=5V, I_O=5mA$)	68	---	---	
R_1	Input resistance	32.9	47	61.1	K Ω
R_2/R_1	Resistance ratio	0.8	1.0	1.2	
f_T	Transition frequency ($V_{CE}=10V, I_E=5mA, f=100MHz$)	---	250	---	MHz

Equivalent circuit

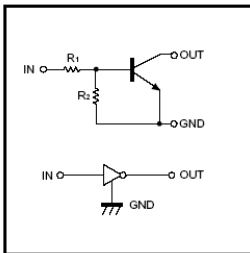

NPN Digital Transistors

SOT-23

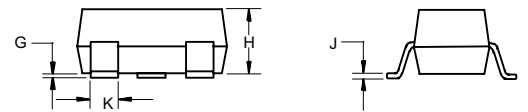
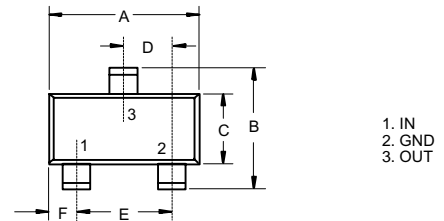

DIM	INCHES		MM		NOTE
	MIN	MAX	MIN	MAX	
A	.110	.120	2.80	3.04	
B	.083	.098	2.10	2.64	
C	.047	.055	1.20	1.40	
D	.035	.041	.89	1.03	
E	.070	.081	1.78	2.05	
F	.018	.024	.45	.60	
G	.0005	.0039	.013	.100	
H	.035	.044	.89	1.12	
J	.003	.007	.085	.180	
K	.015	.020	.37	.51	

Suggested Solder Pad Layout

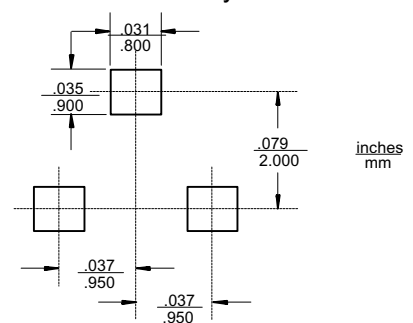

DTC144ECA

● Electrical characteristic curves

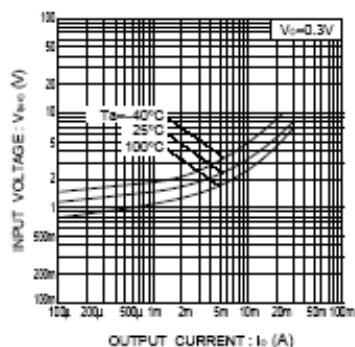

Fig.1 Input voltage vs. output current (ON characteristics)

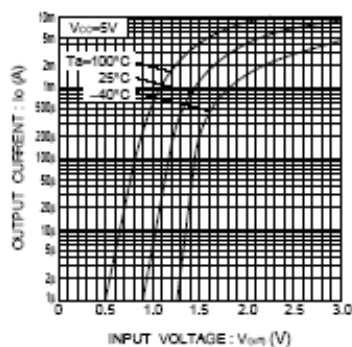

Fig.2 Output current vs. input voltage (OFF characteristics)

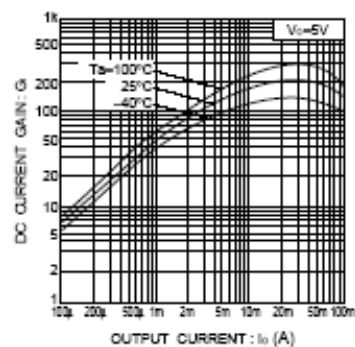

Fig.3 DC current gain vs. output current

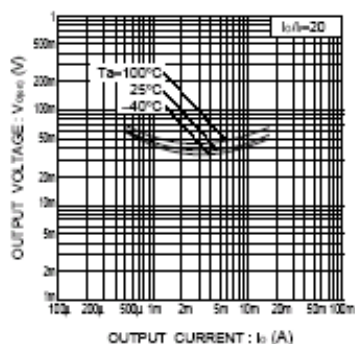

Fig.4 Output voltage vs. output current



Micro Commercial Components

Ordering Information

Device	Packing
(Part Number)-TP	Tape&Reel;3Kpcs/Reel

IMPORTANT NOTICE

Micro Commercial Components Corp. reserves the right to make changes without further notice to any product herein to make corrections, modifications, enhancements, improvements, or other changes. *Micro Commercial Components Corp.* does not assume any liability arising out of the application or use of any product described herein; neither does it convey any license under its patent rights, nor the rights of others. The user of products in such applications shall assume all risks of such use and will agree to hold *Micro Commercial Components Corp.* and all the companies whose products are represented on our website, harmless against all damages.

APPLICATIONS DISCLAIMER

Products offer by *Micro Commercial Components Corp.* are not intended for use in Medical, Aerospace or Military Applications.

www.mccsemi.com